



SECURIFORT
INC



- ❖ **Tool Resistant**
- ❖ **TL-15 series bank rated**
- ❖ **Double re-locking system**



**UL Tool Resistant
Plate Safe**

PC 454



1718-12



2118-16.5



3722-20

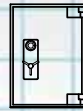

3726-20



4922-20



4926-20



6122-20

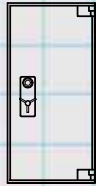

6631-20

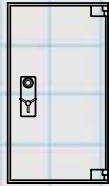
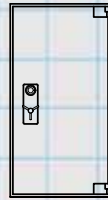
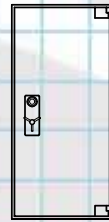
6636-20
6636-267136-20
7136-26

7936-26

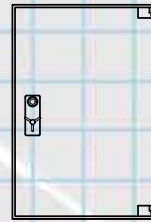

7952-26

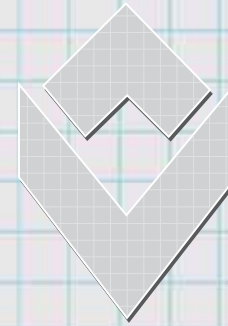
**SECURIFORT**
INC**TOOL-RESISTANT
PLATE SAFE
TL-15**

MODELS	INSIDE DIMENSIONS			OUTSIDE DIMENSIONS			CLEAR OPEN		OVERALL DEPTH	cu. ft. Capacity	WEIGHT	SHELVES QTY
	HEIGHT	WIDTH	DEPTH	HEIGHT	WIDTH	DEPTH	HEIGHT	WIDTH				
1718-12	17"	18"	12"	19"	20"	17"	16 1/2"	16 1/2"	19"	2,12	535 lbs	1
2118-16.5	21"	18"	16 1/2"	23"	20"	21 1/2"	20 1/2"	16 1/2"	23 1/2"	3,60	715 lbs	2
3722-20	37"	22"	20"	39"	24"	25"	36 1/2"	20 1/2"	27"	9,42	1325 lbs	3
3726-20	37"	26"	20"	39"	28"	25"	36 1/2"	24 1/2"	27"	11,13	1470 lbs	3
4922-20	49"	22"	20"	51"	24"	25"	48 1/2"	20 1/2"	27"	12,47	1645 lbs	4
4926-20	49"	26"	20"	51"	28"	25"	48 1/2"	24 1/2"	27"	14,74	1812 lbs	4
6122-20	61"	22"	20"	63"	24"	25"	60 1/2"	20 1/2"	27"	15,53	1965 lbs	5
6631-20	66"	31"	20"	68"	33"	25"	65 1/2"	29 1/2"	27"	23,68	2565 lbs	5
6636-20	66"	36"	20"	68"	38"	25"	65 1/2"	34 1/2"	27"	27,50	2820 lbs	5
6636-26	66"	36"	26"	68"	38"	31"	65 1/2"	34 1/2"	33"	35,75	3175 lbs	5
7136-20	71"	36"	20"	73"	38"	25"	70 1/2"	34 1/2"	27"	29,58	2995 lbs	6
7136-26	71"	36"	26"	73"	38"	31"	70 1/2"	34 1/2"	33"	38,45	3365 lbs	6
7936-26	79"	36"	26"	81"	38"	31"	78 1/2"	34 1/2"	33"	42,79	3670 lbs	6
7952-26	79"	52"	26"	81"	54"	31"	78 1/2"	50 1/2"	33"	61,81	4665 lbs	6

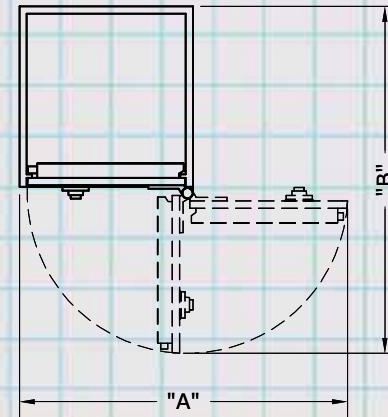

MODELS	DOOR SWING DIMENSIONS	
	"A"	"B"
1718-12	37 1/2"	36"
2118-16.5	37 1/2"	40"
3722-20	45 1/2"	48"
3726-20	53 1/2"	52"
4922-20	45 1/2"	48"
4926-20	53 1/2"	52"
6122-20	45 1/2"	48"
6631-20	63 1/2"	57"
6636-20	73 1/2"	62"
6636-26	73 1/2"	68"
7136-20	73 1/2"	62"
7136-26	73 1/2"	68"
7936-26	73 1/2"	68"
7952-26	104 1/2"	84"

MEGASAFE
HIGH SECURITY SAFES
(800) 345-6552 www.megasafe.com